

The measure
of all things



Precision and continuity

Ever since its foundation in 1883 Kroeplin have been involved in development and production of handy reliable and precise gauges for the measurement of lengths and thicknesses, especially for the metalworking industry.

Thus the quickest system was created, which was the basis for all further innovations and also for the electronic dial indicators. Experience is the solid foundation for quality.

Careful observation and analysis of the market, flexible realization of requirements, convincing measuring concepts - that is the philosophy that makes Kroeplin successful.

Today like before, for more than 135 years.



DIN EN ISO9001:2015

The challenges for the future will be to face market changes, global change as well as ever-shorter development times and to use these challenges to ensure the future of the company.

Features

- Certificate of quality
- Reliable repeatability
- Scales are well arranged and easy to read
- Scale interval from 0.005 mm up (mechanical gauges)
- Numerical interval from 0.001 mm up (electronic gauges)
- Tolerance marks easy to read
- All mechanical gauges are also available in inch
- The electronic gauges can be switched over to inch
- Measuring contacts are mainly made of carbide
- Electronic gauges with analog/ digital display for better reading
- Digimatic interface
- USB interface
- U-WAVE interface
- Bluetooth interface
- Ergonomically designed
- Measuring programs and contacts for different applications
- Absolute and relative measurement
- Red/ Green LED for tolerance measurement (electronic gauges)
- Special solutions possible
- Stand holding unit for serial measurement of small parts
- Convincing price for convincing performance

Subject to technical alterations.

Contents

Internal measurement	
Application range up to 60 mm	4–5
Application range up to 120 mm	6–7
Application range exceeding 120 mm	8–9
Internal comparison measurement	10–11
External measurement	
Application range up to 30 mm	12–13
Application range up to 200 mm	14–15
Tube wall measurement	
Application range up to 100 mm	16–17
Measurement of foamed material and foils	
Application range up to 100 mm	18–19
Internal measurement with 3-point contact	20
Accessories Interfaces	21
Special gauges	22
Definitions	23
Foam inlays	23



Detailed information and data sheets for all gauges are available on our webpage.

www.kroeplin.com

The first electronic quicktest with μm resolution and induction charging technology!

New design and optimized ergonomics.

- Fast reading
- Storage of measuring results
- Precise measuring results
- Quicktest in smallest design
- Numerical interval 0.001 / 0.002 / 0.005 / 0.01 mm
- Lower weight
- Enhanced analog display for optimum reading:
 - 250° analog display range
 - Long analog indicator
- LiPo battery pack with induction charging technology. Battery change is no longer required!



The established generation of quicktests

electronic



- Protection class IP67
- Interactive keypad
- Digital display with analog bar
- Numerical interval adjustable 0,001 / 0,002 / 0,005 / 0,01 / 0,02 / 0,05 mm
- ergonomically designed
- Interfaces USB, Digimatic or U-Wave® available on request
- Data Logger (100 measuring values)
- Bluetooth interface up to 8 gauges simultaneously
- Battery 2x type AAA

mechanical



- Protection class IP65
- optimized measuring force
- accurate measurement
- ergonomically designed

- Measuring programs for different applications MIN / MAX / HOLD
- Bluetooth interface (up to 8 gauges simultaneously)
- USB, Digimatic and U-Wave® interface
- Compatible to Elias, BOBE, IBR
- Data logger (100 measuring values)
- Protection class IP67
- mm / inch switch



Charging station with power supply 8006-20



Can be connected to any device using Bluetooth.



Internal measurement

Application range up to 60 mm



G002



L102



L210

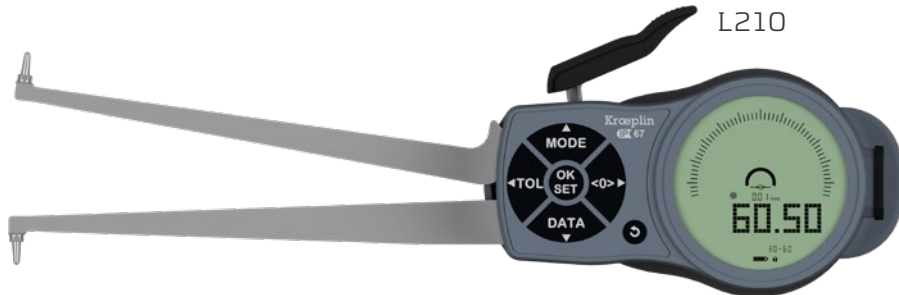

L330



H105



H210

Type	Measuring span Mes [mm]	Measuring range Meb [mm]	Range of indication AzB [mm]	Numerical interval Zw Scale interval Skw [mm]	Permissible errors G [mm]	Repeatability limit r [mm]	Measuring force F_{min} [N]	Measuring force F_{max} [N]	Weight [g]	Protection class	Measuring contact movable Hb [mm]	Measuring contact fixed Hf [mm]	Type of measuring contact [mm]	Groove depth A max. [mm]	Groove width B min. [mm]	Measuring depth L max. [mm]	Picture	Electronic E Mechanical M	Wooden box
G002	10	2.5-12.5	2,4-12,8	0,001	0.010	0.005	0.8	1.3	160	IP67	0.9	0.9	Chisel R 0.12	0.7	0.6	12	[1]	E	1732-38
G005	15	5-20	4,7-20,5	0,001	0.010	0.005	0.8	1.3	160	IP67	2.2	2.2	Ball Ø 0.6	2.2	0.8	44	[2]	E	1732-38
G010	15	10-25	9,7-25,5	0,001	0.010	0.005	0.8	1.3	160	IP67	4.4	4.4	Ball Ø 1	4	1.5	46	[2]	E	1732-38
L102	10	2.5-12.5	2,4-12,8	0,005	0.015	0.005	0.8	1.2	245	IP67	0.9	0.9	Chisel R 0.12	0.7	0.5	12	[1]	E	1732-65
H102	10	2.5-12.5	2,4-12,8	0,005	0.015	0.005	0.8	1.2	155	IP65	0.9	0.9	Chisel R 0.12	0.7	0.5	12	[1]	M	1732-45
L105	10	5-15	4,7-15,3	0,005	0.015	0.005	0.8	1.2	250	IP67	2.5	2.5	Ball Ø 0.6	2.3	0.8	35	[2]	E	1732-65
H105	10	5-15	4,7-15,3	0,005	0.015	0.005	0.8	1.2	160	IP65	2.5	2.5	Ball Ø 0.6	2.3	0.8	35	[2]	M	1732-45
L210	20	10-30	9,5-30,5	0,01	0.03	0.01	1.1	1.6	270	IP67	5.3	5.3	Ball Ø 1	5.2	1.5	85	[2]	E	1732-65
H210	20	10-30	9,5-30,5	0,01	0.03	0.01	1.1	1.6	180	IP65	5.3	5.3	Ball Ø 1	5.2	1.5	85	[2]	M	1732-45
L220	20	20-40	19,5-40,5	0,01	0.03	0.01	1.1	1.6	270	IP67	7.3	7.3	Ball Ø 1	7.0	1.5	85	[4]	E	1732-65
H220	20	20-40	19,5-40,5	0,01	0.03	0.01	1.1	1.6	180	IP65	7.3	7.3	Ball Ø 1	7.0	1.5	85	[4]	M	1732-45
L230	20	30-50	29,5-50,5	0,01	0.03	0.01	1.1	1.6	275	IP67	7.3	7.3	Ball Ø 1	7.0	1.5	85	[4]	E	1732-65
H230	20	30-50	29,5-50,5	0,01	0.03	0.01	1.1	1.6	185	IP65	7.3	7.3	Ball Ø 1	7.0	1.5	85	[4]	M	1732-45
L240	20	40-60	39,5-60,5	0,01	0.03	0.01	1.1	1.6	285	IP67	8.5	8.5	Ball Ø 1	8.3	1.5	85	[5]	E	1732-65
H240	20	40-60	39,5-60,5	0,01	0.03	0.01	1.1	1.6	195	IP65	8.5	8.5	Ball Ø 1	8.3	1.5	85	[5]	M	1732-45
L313	30	13-43	12,8-43,5	0,01	0.04	0.02	1.2	1.7	360	IP67	5.9	5.9	Ball Ø 1.3	5.7	1.6	127	[2]	E	1732-71
L330	30	30-60	29,5-60,5	0,01	0.04	0.02	1.2	1.7	370	IP67	6.5	6.5	Ball Ø 1.5	6.2	1.8	132	[5]	E	1732-71

Measuring contacts

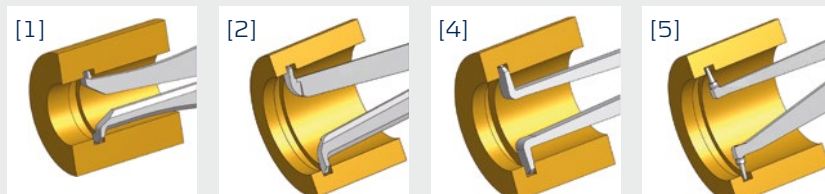

Chisel R 0.12 mm

Ball Ø 0.6 mm
Ball Ø 1.0 mm
Ball Ø 1.3 mm

Ball Ø 1.0 mm

Ball Ø 1.0 mm
Ball Ø 1.5 mm
Ball Ø 2.0 mm

Measuring capacity

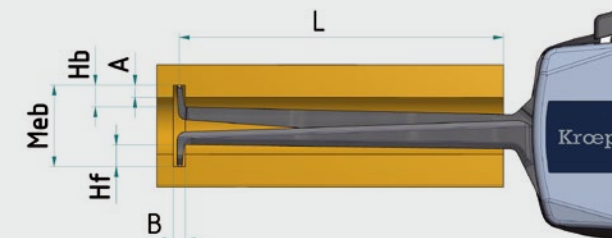

Meb Measuring range

A Groove depth

B Groove width

Hb Measuring contact movable

Hf Measuring contact fixed

L Measuring depth

Internal measurement

Application range up to 120 mm



L240



H240



L370

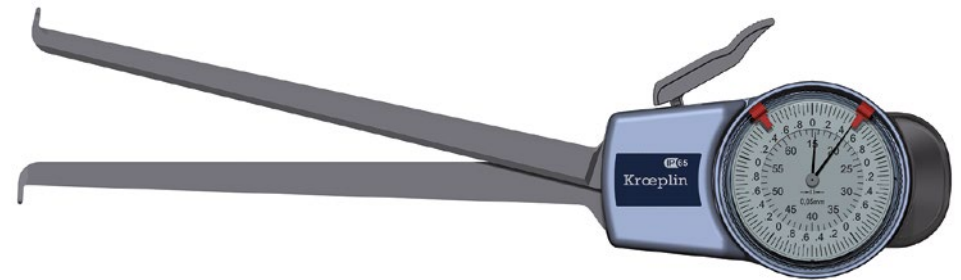

H415

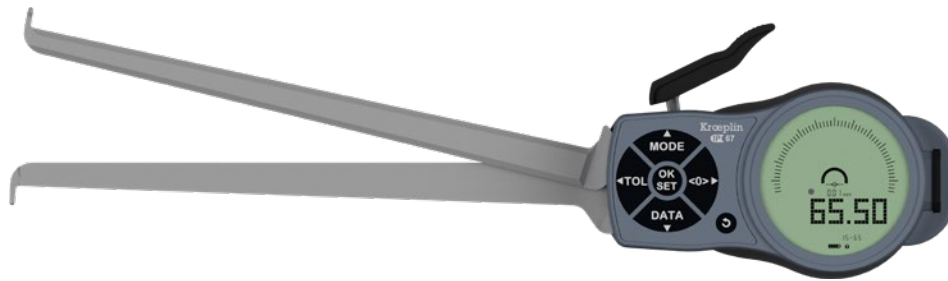

L415



H470

Type	Measuring span Mes [mm]	Measuring range Meb [mm]	Range of indication AzB [mm]	Numerical interval Zw Scale interval Skw [mm]	Permissible errors G [mm]	Repeatability limit r [mm]	Measuring force F_{min} [N]	Measuring force F_{max} [N]	Weight [g]	Protection class	Measuring contact movable Hb [mm]	Measuring contact fixed Hf [mm]	Type of measuring contact [mm]	Groove depth A max. [mm]	Groove width B min. [mm]	Measuring depth L max. [mm]	Picture	Electronic E Mechanical M	Wooden box
L250	20	50-70	49,5-70,5	0,01	0,03	0,01	1,1	1,6	285	IP67	8.5	8.5	Ball Ø 1	8.3	1,5	85	[5]	E	1732-65
H250	20	50-70	49,5-70,5	0,01	0,03	0,01	1,1	1,6	195	IP65	8.5	8.5	Ball Ø 1	8.3	1,5	85	[5]	M	1732-45
L260	20	60-80	59,5-80,5	0,01	0,03	0,01	1,1	1,6	290	IP67	8.5	8.5	Ball Ø 1	8.3	1,5	85	[5]	E	1732-65
H260	20	60-80	59,5-80,5	0,01	0,03	0,01	1,1	1,6	200	IP65	8.5	8.5	Ball Ø 1	8.3	1,5	85	[5]	M	1732-45
L270	20	70-90	69,5-90,5	0,01	0,03	0,01	1,1	1,6	290	IP67	8.5	8.5	Ball Ø 1	8.3	1,5	85	[5]	E	1732-65
H270	20	70-90	69,5-90,5	0,01	0,03	0,01	1,1	1,6	200	IP65	8.5	8.5	Ball Ø 1	8.3	1,5	85	[5]	M	1732-45
L280	20	80-100	79,5-100,5	0,01	0,03	0,01	1,1	1,6	290	IP67	8.5	8.5	Ball Ø 1	8.3	1,5	85	[5]	E	1732-65
H280	20	80-100	79,5-100,5	0,01	0,03	0,01	1,1	1,6	200	IP65	8.5	8.5	Ball Ø 1	8.3	1,5	85	[5]	M	1732-45
L350	30	50-80	49,5-80,5	0,01	0,04	0,02	1,2	1,7	370	IP67	8.5	8.5	Ball Ø 2	8.3	2,5	132	[5]	E	1732-71
L370	30	70-100	69,5-100,5	0,01	0,04	0,02	1,2	1,7	375	IP67	8.5	8.5	Ball Ø 2	8.3	2,5	132	[5]	E	1732-71
L390	30	90-120	89,5-120,5	0,01	0,04	0,02	1,2	1,7	380	IP67	8.5	8.5	Ball Ø 2	8.3	2,5	132	[5]	E	1732-71
L415	50	15-65	14,8-65,5	0,01	0,05	0,03	1,0	1,8	415	IP67	6.0	6.0	Ball Ø 1.5	5.5	2,0	188	[3]	E	1732-71
H415	50	15-65	14,8-65,5	0,05	0,05	0,025	0,9	1,9	355	IP65	6.0	6.0	Ball Ø 1.5	5.5	2,0	188	[3]	M	1732-51
L440	50	40-90	39,5-90,5	0,01	0,05	0,03	1,0	1,8	420	IP67	8.5	8.5	Ball Ø 2	8.3	2,5	192	[5]	E	1732-71
H440	50	40-90	39,5-90,5	0,05	0,05	0,025	0,9	1,9	370	IP65	8.5	8.5	Ball Ø 2	8.3	2,5	192	[5]	M	1732-51
L470	50	70-120	69,5-120,5	0,01	0,05	0,03	1,0	1,8	420	IP67	8.5	8.5	Ball Ø 2	8.3	2,5	192	[5]	E	1732-71
H470	50	70-120	69,5-120,5	0,05	0,05	0,025	0,9	1,9	370	IP65	8.5	8.5	Ball Ø 2	8.3	2,5	192	[5]	M	1732-51

Measuring contacts

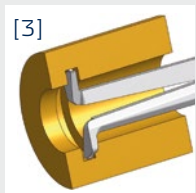

Ball Ø 1.0 mm
Ball Ø 1.5 mm

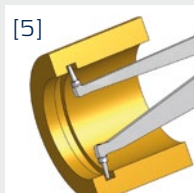

Ball Ø 1.0 mm
Ball Ø 2.0 mm

Measuring capacity

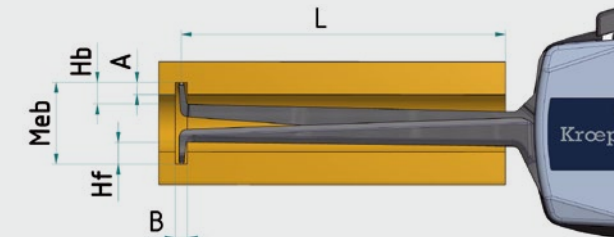

Meb Measuring range
A Groove depth
B Groove width
Hb Measuring contact movable
Hf Measuring contact fixed
L Measuring depth

Internal measurement

Application range exceeding 120 mm

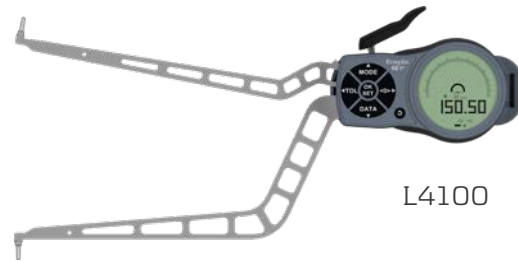

L4100

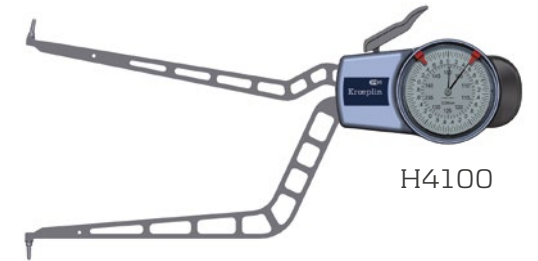

H4100



L850



H870



G16200

Type	Measuring span Mes [mm]	Measuring range Meb [mm]	Range of indication AzB [mm]	Numerical interval Zw Scale interval Skw [mm]	Permissible errors G [mm]	Repeatability limit r [mm]	Measuring force F_{min} [N]	Measuring force F_{max} [N]	Weight [g]	Protection class	Measuring contact movable Hb [mm]	Measuring contact fixed Hf [mm]	Type of measuring contact [mm]	Groove depth A max. [mm]	Groove width B min. [mm]	Measuring depth L max. [mm]	Picture	Electronic E Mechanical M	Wooden box
L4100	50	100-150	99,5-150,5	0,01	0,05	0,03	1,0	1,8	425	IP67	8,5	8,5	Ball Ø 2	8.3	2.4	192	[5]	E	1732-71
H4100	50	100-150	99,5-150,5	0,05	0,05	0,025	0,9	1,9	385	IP65	8,5	8,5	Ball Ø 2	8.3	2.4	192	[5]	M	1732-51
L4130	50	130-180	129,5-180,5	0,01	0,05	0,03	1,0	1,8	430	IP67	8,5	8,5	Ball Ø 2	8.3	2.4	192	[5]	E	HK
H4130	50	130-180	129,5-180,5	0,05	0,05	0,025	0,9	1,9	390	IP65	8,5	8,5	Ball Ø 2	8.3	2.4	192	[5]	M	HK
L4150	50	150-200	149,5-200,5	0,01	0,05	0,03	1,0	1,8	435	IP67	8,5	8,5	Ball Ø 2	8.3	2.4	192	[5]	E	HK
H4150	50	150-200	149,5-200,5	0,05	0,05	0,025	0,9	1,9	395	IP65	8,5	8,5	Ball Ø 2	8.3	2.4	192	[5]	M	HK
L850	100	50-150	49,5-150,5	0,05	0,15	0,1	0,8	2,0	650	IP67	4,0	4,0	Ball Ø 5	3.0	5.5	395	[18]	E	HK
H850	100	50-150	49,5-150,5	0,1	0,15	0,1	0,8	2,0	590	IP65	4,0	4,0	Ball Ø 5	3.0	5.5	395	[18]	M	HK
L870	100	70-170	69,5-170,5	0,05	0,15	0,1	0,8	2,0	650	IP67	14,0	14,0	Ball Ø 5	13.0	5.5	395	[19]	E	HK
H870	100	70-170	69,5-170,5	0,1	0,15	0,1	0,8	2,0	590	IP65	14,0	14,0	Ball Ø 5	13.0	5.5	395	[19]	M	HK
G1290	100	90-190	89-191	0,1	0,3	0,1	1,0	1,5	910	-	13	13	Ball Ø 5	12	5.5	535	[19]	E	HK
H1290	100	90-190	89-191	0,1	0,3	0,1	1,0	1,5	950	-	13	13	Ball Ø 5	12	5.5	535	[19]	M	HK
G12150	100	150-250	149-251	0,1	0,3	0,1	1,0	1,5	920	-	30	30	Ball Ø 5	29	5.5	535	[19]	E	HK
H12150	100	150-250	149-251	0,1	0,3	0,1	1,0	1,5	960	-	30	30	Ball Ø 5	29	5.5	535	[19]	M	HK
G16200	200	200-400	199-401	0,2	0,4	0,2	0,7	1,6	1200	-	29	29	Hemisphere SR 20	28	21	720	[20]	E	HK
H16200	200	200-400	199-401	0,2	0,4	0,2	0,7	1,6	1300	-	29	29	Hemisphere SR 20	28	21	720	[20]	M	HK

Measuring contacts



Ball Ø 2.0 mm

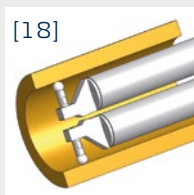

Ball Ø 5.0 mm

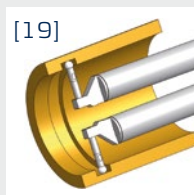

Ball Ø 5.0 mm



Hemisphere SR 20 mm

Measuring capacity

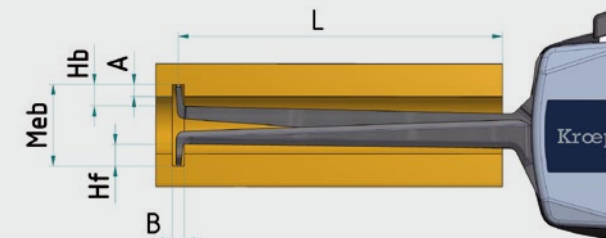

Meb Measuring range

A Groove depth

B Groove width

Hb Measuring contact movable

Hf Measuring contact fixed

L Measuring depth

Internal comparison measurement

Application range from 50 to 430 mm



H4M180



H2M50



H2M90



Detailed information and data sheets for all gauges are available on our webpage.

www.kroepelin.com

Type	Measuring span Mes [mm]	Measuring range Meb [mm]	Range of indication Azb [mm]	Scale interval Skw [mm]	Permissible errors G [mm]	Repeatability limit r [mm]	Measuring force F_{min} [N]	Measuring force F_{max} [N]	Weight [g]	Protection class	Measuring contact movable Hb [mm]	Measuring contact fixed Hf [mm]	Type of measuring contact [mm]	Groove depth A max. [mm]	Groove width B min. [mm]	Measuring depth L max. [mm]	Picture	Electronic E	Mechanical M	Wooden box
H2M50	20	50-100	49.5-100.5	0.01	0.03	0.015	1.1	1.6	220	IP65	12.0	variable	Ball Ø 1	8.3	1,5	85	[5]	M		HK
H2M90	20	90-140	89.5-140.5	0.01	0.03	0.015	1.1	1.6	230	IP65	12.0	variable	Ball Ø 1	8.3	1,5	85	[5]	M		HK
H2M130	20	130-180	129.5-180.5	0.01	0.03	0.015	1.1	1.6	240	IP65	12.0	variable	Ball Ø 1	8.3	1,5	85	[5]	M		HK
H4M180	50	180-310	179.5-310.5	0.05	0.10	0.05	0.9	1.9	420	IP65	21.0	variable	Ball Ø 2	8.3	2,5	170	[5]	M		HK
H4M300	50	300-430	299.5-430.5	0.05	0.15	0.05	0.9	1.9	450	IP65	21.0	variable	Ball Ø 2	8.3	2,5	170	[5]	M		HK

Measuring contact



Ball Ø 1.0 mm
Ball Ø 2.0 mm

Measuring capacity

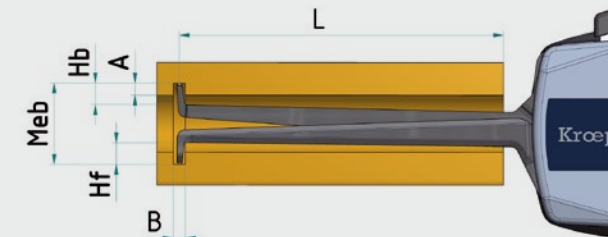

Meb Measuring range
A Groove depth
B Groove width
Hb Measuring contact movable
Hf Measuring contact fixed
L Measuring depth

External measurement

Application range up to 30 mm



C015



D110S



K220



D220



K330

Type	Measuring span Mes [mm]	Measuring range Meb [mm]	Range of indication AzB [mm]	Numerical interval Zw Scale interval Skw [mm]	Permissible errors G [mm]	Repeatability limit r [mm]	Measuring force F_{min} [N]	Measuring force F_{max} [N]	Weight [g]	Protection class	Measuring contact movable Hb [mm]	Measuring contact fixed Hf [mm]	Type of measuring contact [mm]	Measuring depth L max. [mm]	Picture	Electronic E Mechanical M	Wooden box
C015	15	0-15	0-15,5	0,001	0,010	0,005	1,3	1,5	170	IP67	17	17	Ball Ø 1.5	45	[6]	E	1732-38
C015S	15	0-15	0-15,5	0,001	0,015	0,005	1,3	1,5	170	IP67	12	12	Chisel R 0.4	45	[7]	E	1732-38
K110	10	0-10	0-10,5	0,005	0,015	0,005	1,2	1,6	260	IP67	19,1	18,6	Ball Ø 1.5	35	[6]	E	1732-65
D110	10	0-10	0-10,5	0,005	0,015	0,005	1,2	1,6	170	IP65	19,1	18,6	Ball Ø 1.5	35	[6]	M	1732-45
K110S	10	0-10	0-10,5	0,005	0,015	0,005	1,2	1,6	260	IP67	18,8	18,5	Chisel R 0.4	35	[7]	E	1732-65
D110S	10	0-10	0-10,5	0,005	0,015	0,005	1,2	1,6	170	IP65	18,8	18,5	Chisel R 0.4	35	[7]	M	1732-45
K220	20	0-20	0-20,5	0,01	0,03	0,01	1,1	1,6	300	IP67	24,7	24,6	Ball Ø 1.5	85	[6]	E	1732-65
D220	20	0-20	0-20,5	0,01	0,03	0,01	1,1	1,6	210	IP65	24,7	24,6	Ball Ø 1.5	85	[6]	M	1732-45
K220S	20	0-20	0-20,5	0,01	0,03	0,01	1,1	1,6	300	IP67	24,7	24,6	Chisel R 0.4	85	[7]	E	1732-65
D220S	20	0-20	0-20,5	0,01	0,03	0,01	1,1	1,6	210	IP65	24,7	24,6	Chisel R 0.4	85	[7]	M	1732-45
K330	30	0-30	0-30,5	0,01	0,04	0,02	0,9	1,6	430	IP67	30	30	Ball Ø 3	116	[6]	E	1732-71
K330S	30	0-30	0-30,5	0,01	0,04	0,02	0,9	1,6	430	IP67	30	30	Chisel R 0.75	116	[7]	E	1732-71

Measuring contacts

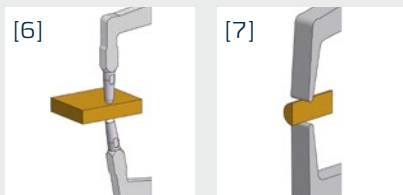

Ball Ø 1.5 mm
Ball Ø 3.0 mm

Chisel R 0.4 mm
Chisel R 0.75 mm

Measuring capacity

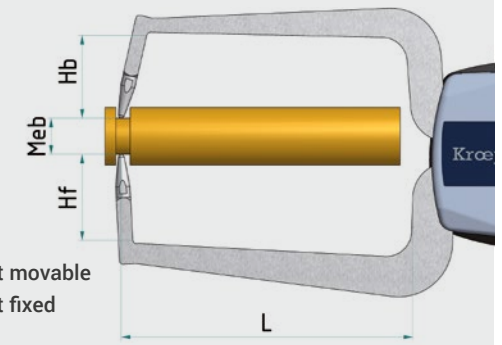

Meb Measuring range
Hb Measuring contact movable
Hf Measuring contact fixed
L Measuring depth

External measurement

Application range up to 200 mm

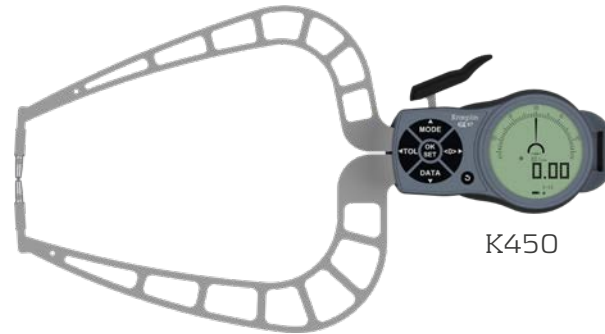

K450

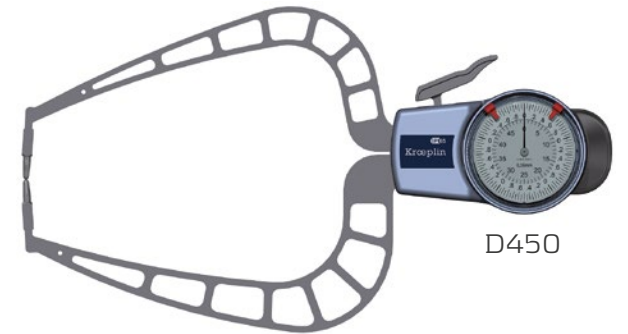

D450



K8100

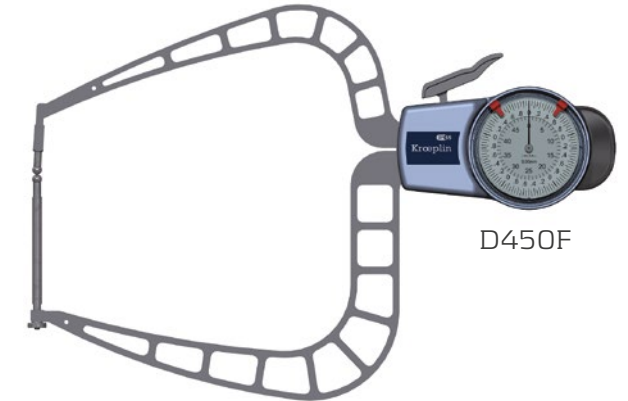

D450F



C16200

Type	Measuring span Mes [mm]	Measuring range Meb [mm]	Range of indication Azb [mm]	Numerical interval Zw Scale interval Skw [mm]	Permissible errors G [mm]	Repeatability limit r [mm]	Measuring force F_{min} [N]	Measuring force F_{max} [N]	Weight [g]	Protection class	Measuring contact movable Hb [mm]	Measuring contact fixed Hf [mm]	Type of measuring contact [mm]	Measuring depth L max. [mm]	Picture	Electronic E Mechanical M	Wooden box
K450	50	0-50	0-50,5	0,01	0,05	0,03	0,8	1,7	490	IP67	30	30	Ball Ø 3	167	[6]	E	1732-71
D450	50	0-50	0-50,5	0,05	0,05	0,025	0,8	1,7	430	IP65	30	30	Ball Ø 3	167	[6]	M	1732-51
K450S	50	0-50	0-50,5	0,01	0,05	0,03	0,8	1,7	490	IP67	30	30	Chisel R 0.75	167	[7]	E	1732-71
D450S	50	0-50	0-50,5	0,05	0,05	0,025	0,8	1,7	430	IP65	30	30	Chisel R 0.75	167	[7]	M	1732-51
K450B	50	0-50	0-50,5	0,01	0,06	0,04	0,8	1,7	510	IP67	72,6	30	Ball Ø 5	167	[6]	E	HK
D450B	50	0-50	0-50,5	0,05	0,075	0,05	0,8	1,7	450	IP65	72,6	30	Ball Ø 5	167	[6]	M	HK
K450F	50	0-50	0-50,5	0,01	0,06	0,04	0,8	1,7	510	IP67	30	72,6	Ball Ø 5	167	[6]	E	HK
D450F	50	0-50	0-50,5	0,05	0,075	0,05	0,8	1,7	450	IP65	30	72,6	Ball Ø 5	167	[6]	M	HK
K4100	50	50-100	49,5-100,5	0,01	0,06	0,04	0,8	1,7	510	IP67	30	23	Ball Ø 5	167	[6]	E	HK
D4100	50	50-100	49,5-100,5	0,05	0,075	0,05	0,8	1,7	450	IP65	30	23	Ball Ø 5	167	[6]	M	HK
K4150	50	100-150	99,5-150,5	0,01	0,06	0,04	0,8	1,7	530	IP67	30	23	Ball Ø 5	167	[6]	E	HK
D4150	50	100-150	99,5-150,5	0,05	0,075	0,05	0,8	1,7	470	IP65	30	23	Ball Ø 5	167	[6]	M	HK
K8100	100	0-100	0-101	0,05	0,15	0,1	0,8	1,8	660	IP67	33	33	Ball Ø 5	375	[16]	E	HK
D8100	100	0-100	0-101	0,1	0,15	0,1	0,8	1,8	600	IP65	33	33	Ball Ø 5	375	[16]	M	HK
C12100	100	0-100	0-101	0,1	0,3	0,2	1,2	1,8	950	-	30	30	Ball Ø 5	530	[16]	E	HK
D12100	100	0-100	0-101	0,1	0,3	0,2	1,2	1,8	1000	-	30	30	Ball Ø 5	530	[16]	M	HK
C12100BJ	100	0-100	0-101	0,1	0,3	0,2	1,2	1,8	1100	-	30	124	Ball Ø 5	530	[16]	E	HK
D12100BJ	100	0-100	0-101	0,1	0,3	0,2	1,2	1,8	1100	-	30	124	Ball Ø 5	530	[16]	M	HK
C16200	200	0-200	0-201	0,2	0,4	0,2	0,8	1,5	1300	-	98	98	Hemisphere SR 20	728	[17]	E	HK
D16200	200	0-200	0-201	0,2	0,4	0,2	0,8	1,5	1400	-	98	98	Hemisphere SR 20	728	[17]	M	HK

Measuring contacts

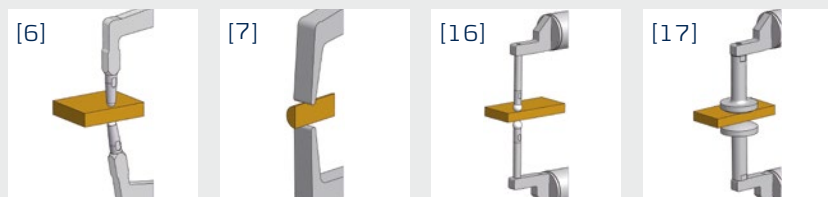

Ball Ø 3.0 mm
Ball Ø 5.0 mm

Chisel R 0.75 mm

Ball Ø 5.0 mm

Hemisphere SR 20 mm

Measuring capacity

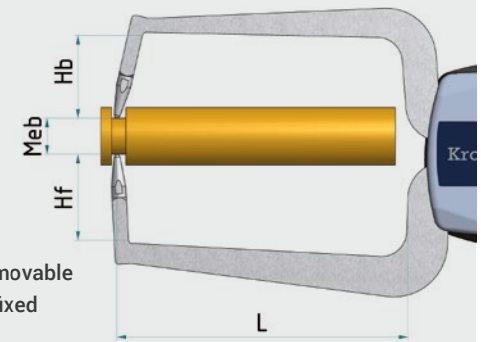

Meb Measuring range

Hb Measuring contact movable

Hf Measuring contact fixed

L Measuring depth

Tube wall measurement

Application range up to 100 mm



COR155



D1R10



K1R10



D2R20

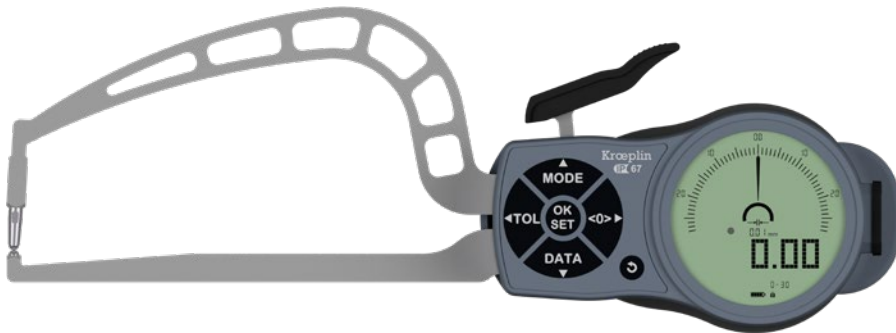

K3R30



D4R50

Type	Measuring span Mes [mm]	Measuring range Meb [mm]	Range of indication Azb [mm]	Numerical interval Zw Scale interval Skw [mm]	Permissible errors G [mm]	Repeatability limit r [mm]	Measuring force F _{min} [N]	Measuring force F _{max} [N]	Weight [g]	Protection class	Type of measuring contact movable [mm]	Measuring contact movable Hb [mm]	Type of measuring contact fixed [mm]	Measuring contact fixed Hf [mm]	bore diameter d min.	Measuring depth L max. [mm]	Picture	Electronic E Mechanical M	Wooden box
C0R15	15	0-15	0-15,5	0,001	0,01	0,005	1,3	1,5	165	IP67	Ball Ø 1.5	17	Ball Ø 1.5	0.9	4	46	[8]	E	1732-38
C0R15S	15	0-15	0-15,5	0,001	0,01	0,005	1,3	1,5	170	IP67	Chisel Ø 0.4	12	Ball Ø 1.5	0.9	4	46	[9]	E	1732-38
K1R10	10	0-10	0-10,5	0,005	0,015	0,005	0,8	1,2	255	IP67	Ball Ø 1.5	19.1	Ball Ø 1.5	0.9	3	35	[8]	E	1732-65
D1R10	10	0-10	0-10,5	0,005	0,015	0,005	0,8	1,2	165	IP65	Ball Ø 1.5	19.1	Ball Ø 1.5	0.9	3	35	[8]	M	1732-45
K1R10S	10	0-10	0-10,5	0,005	0,015	0,005	0,8	1,2	255	IP67	Chisel R = 0.4	18.8	Ball Ø 1.5	0.9	3	35	[9]	E	1732-65
D1R10S	10	0-10	0-10,5	0,005	0,015	0,005	0,8	1,2	165	IP65	Chisel R = 0.4	18.8	Ball Ø 1.5	0.9	3	35	[9]	M	1732-45
K2R20	20	0-20	0-20,5	0,01	0,03	0,01	1,1	1,6	290	IP67	Ball Ø 1.5	24.7	Ball Ø 1.5	2.5	9	80	[10]	E	1732-65
D2R20	20	0-20	0-20,5	0,01	0,03	0,01	1,1	1,6	200	IP65	Ball Ø 1.5	24.7	Ball Ø 1.5	2.5	9	80	[10]	M	1732-45
K2R20S	20	0-20	0-20,5	0,01	0,03	0,01	1,1	1,6	290	IP67	Chisel R = 0.4	24.7	Ball Ø 1.5	2.5	9	80	[11]	E	1732-65
D2R20S	20	0-20	0-20,5	0,01	0,03	0,01	1,1	1,6	200	IP65	Chisel R = 0.4	24.7	Ball Ø 1.5	2.5	9	80	[11]	M	1732-45
K3R30	30	0-30	0-30,5	0,01	0,04	0,02	0,9	1,6	410	IP67	Ball Ø 3	30	Ball Ø 3	4	10	116	[10]	E	1732-71
K3R30S	30	0-30	0-30,5	0,01	0,04	0,02	0,9	1,6	410	IP65	Chisel R = 0.75	30	Ball Ø 3	4	10	116	[11]	E	1732-71
K4R50	50	0-50	0-50,5	0,01	0,05	0,03	0,8	1,7	460	IP67	Ball Ø 3	30	Ball Ø 3	4.3	13	169	[10]	E	1732-71
D4R50	50	0-50	0-50,5	0,05	0,05	0,025	0,8	1,7	400	IP65	Ball Ø 3	30	Ball Ø 3	4.3	13	169	[10]	M	1732-51
K4R50S	50	0-50	0-50,5	0,01	0,05	0,03	0,8	1,7	460	IP67	Chisel R = 0.75	30	Ball Ø 3	4.3	13	169	[11]	E	1732-71
D4R50S	50	0-50	0-50,5	0,05	0,05	0,025	0,8	1,7	400	IP65	Chisel R = 0.75	30	Ball Ø 3	4.3	13	169	[11]	M	1732-51
K8R100	100	0-100	0-101	0,05	0,15	0,1	0,8	1,8	660	IP67	Ball Ø 5	35	Ball Ø 5	15	36	382	[15]	E	HK
D8R100	100	0-100	0-101	0,1	0,15	0,1	0,8	1,8	600	IP65	Ball Ø 5	35	Ball Ø 5	15	36	382	[15]	M	HK

Measuring contacts

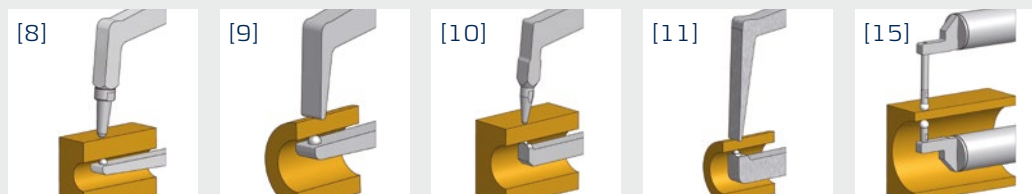

Ball Ø 1.5 mm

Chisel R 0.4 mm
Ball Ø 1.5 mm

Ball Ø 1.5 mm
Ball Ø 2.0 mm
Ball Ø 3.0 mm

Chisel R 0.4 mm
Chisel R 0.75 mm
Ball Ø 1.5 mm
Ball Ø 2.0 mm
Ball Ø 3.0 mm

Ball Ø 5.0 mm

Measuring capacity

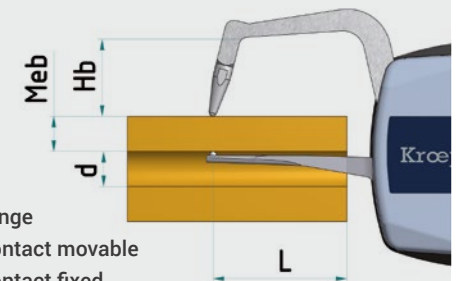

Meb Measuring range

Hb Measuring contact movable

Hf Measuring contact fixed

L Measuring depth

d Diameter

Measurement of foamed material and foils

Application range up to 100 mm



K110T



D110T



K220T



D220T

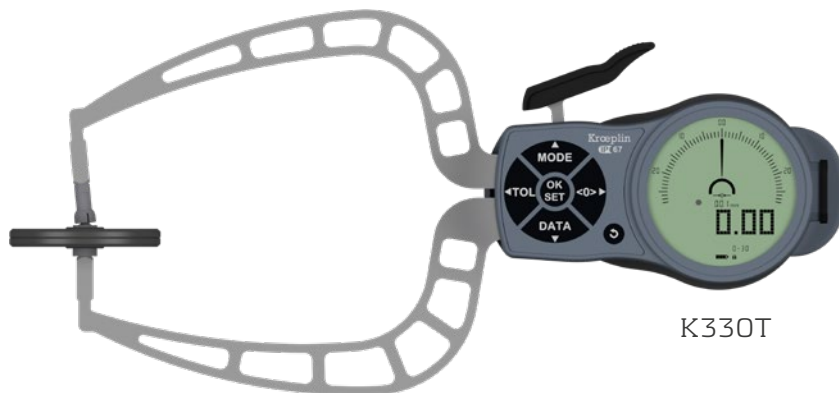

K330T

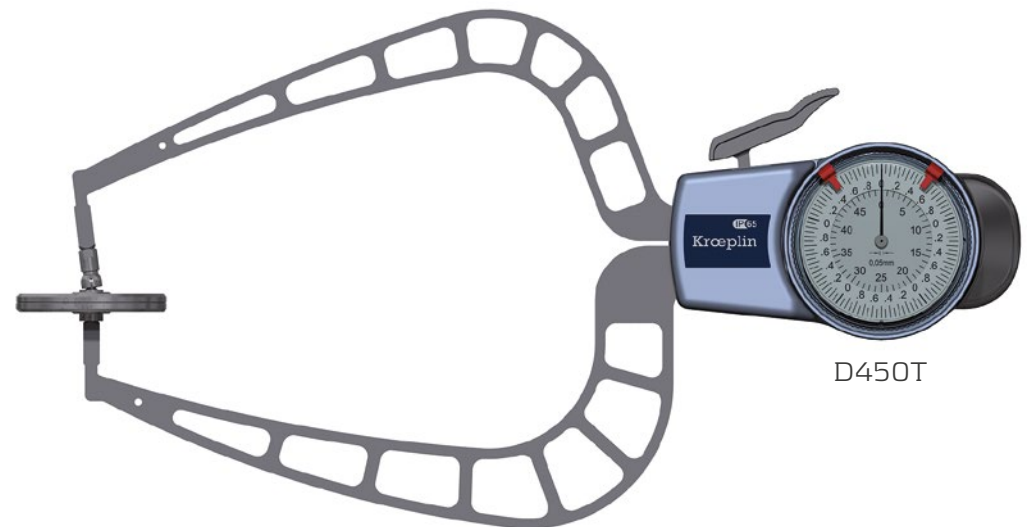

D450T

Type	Measuring span Mes [mm]	Measuring range Meb [mm]	Range of indication AzB [mm]	Numerical interval Zw Scale interval Skw [mm]	Permissible errors G [mm]	Repeatability limit r [mm]	Measuring force F_{min} [N]	Measuring force F_{max} [N]	Weight [g]	Protection class	Measuring contact movable Hb [mm]	Measuring contact fixed Hf [mm]	Type of measuring contact [mm]	Measuring depth L max. [mm]	Picture	Electronic E Mechanical M	Wooden box
K110T	10	0-10	0-10,5	0,005	0,02	0,005	0,8	1,2	265	IP67	21,7	14,8	Flat Ø 6	35	[12]	E	1732-65
D110T	10	0-10	0-10,5	0,005	0,02	0,005	0,8	1,2	175	IP65	21,7	14,8	Flat Ø 6	35	[12]	M	1732-45
K220T	20	0-20	0-20,5	0,01	0,04	0,01	1,1	1,6	310	IP67	28,2	20,7	Flat Ø 10	85	[12]	E	1732-65
D220T	20	0-20	0-20,5	0,01	0,04	0,01	1,1	1,6	220	IP65	28,2	20,7	Flat Ø 10	85	[12]	M	1732-45
K330T	30	0-30	0-30,5	0,01	0,06	0,04	0,9	1,6	430	IP67	36	24	Flat Ø 50	116	[14]	E	1732-71
K450T	50	0-50	0-50,5	0,01	0,06	0,04	0,8	1,7	500	IP67	36	24	Flat Ø 50	167	[14]	E	1732-71
D450T	50	0-50	0-50,5	0,05	0,1	0,05	0,8	1,7	440	IP65	36	24	Flat Ø 50	167	[14]	M	1732-51
K4100T	50	50-100	49,5-100,5	0,01	0,06	0,04	0,8	1,7	520	IP67	36	17	Flat Ø 50	167	[14]	E	HK
D4100T	50	50-100	49,5-100,5	0,05	0,075	0,05	0,8	1,7	450	IP65	36	17	Flat Ø 50	167	[14]	M	HK
K8100T	100	0-100	0-101	0,05	0,15	0,1	0,8	1,8	670	IP67	39	7	Flat Ø 50	375	[14]	E	HK
D8100T	100	0-100	0-101	0,1	0,15	0,1	0,8	1,8	610	IP65	39	7	Flat Ø 50	375	[14]	M	HK
C12100T	100	0-100	0-101	0,1	0,3	0,2	1,6	2,2	1000	-	34	14	Flat Ø 50	550	[14]	E	HK
D12100T	100	0-100	0-101	0,1	0,3	0,2	1,6	2,2	1100	-	34	14	Flat Ø 50	550	[14]	M	HK

Measuring contacts

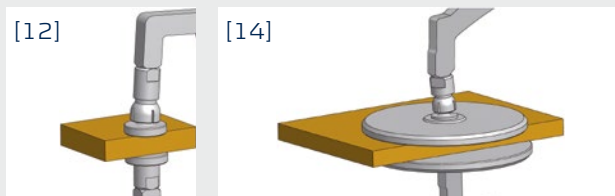

Flat Ø 6 mm
Flat Ø 10 mm

Flat Ø 50 mm

Measuring capacity

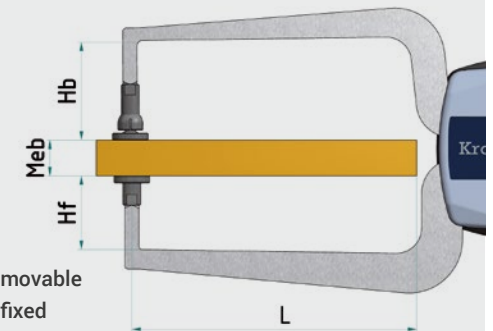

Meb Measuring range
Hb Measuring contact movable
Hf Measuring contact fixed
L Measuring depth

Internal measurement with 3-point contact

Application range from 7 to 105 mm



L210P3

Type	Measuring span Mes [mm]	Measuring range Meb [mm]	Range of indication Azb [mm]	Numerical interval Zw [mm]	Permissible errors G [mm]	Repeatability limit r [mm]	Measuring force F_{min} [N]	Measuring force F_{max} [N]	Weight [g]	Protection class	Measuring contact movable Hb [mm]	Measuring contact fixed Hf [mm]	Type of measuring contact [mm]	Groove depth A max. [mm]	Groove width B min. [mm]	Measuring depth L max. [mm]	Picture	Electronic E	Mechanical M	Wooden box
L107P3	7	7-14	6.8-14.5	0.002	0.01	0.004	1.0	1.4	250	IP67	2.5	-	Ball Ø 0.6	2.2	0.8	34	[1]	E		1732-65
L210P3	10	10-20	9.8-20.5	0.005	0.02	0.01	1.1	1.6	270	IP67	4.6	-	Ball Ø 1	3.5	1.6	75	[2]	E		1732-65
L215P3	15	15-30	14.5-30.5	0.005	0.02	0.01	1.1	1.6	295	IP67	5.8	-	Ball Ø 1	5.0	1.6	77	[2]	E		1732-65
L225P3	20	25-45	24.5-45.5	0.005	0.02	0.01	1.1	1.6	275	IP67	7.3	-	Ball Ø 1	7.0	1.6	84	[3]	E		1732-65
L240P3	20	40-60	39.5-60.5	0.005	0.02	0.01	1.1	1.6	290	IP67	12.2	-	Ball Ø 1	8.0	1.6	84	[3]	E		1732-65
L255P3	20	55-75	54.5-75.5	0.005	0.02	0.01	1.1	1.6	290	IP67	12.2	-	Ball Ø 1	8.0	1.6	84	[3]	E		1732-65
L270P3	20	70-90	69.5-91	0.005	0.02	0.01	1.1	1.6	295	IP67	12.2	-	Ball Ø 1	8.5	1.6	84	[3]	E		1732-65
L285P3	20	85-105	84.5-106	0.005	0.02	0.01	1.1	1.6	305	IP67	12.2	-	Ball Ø 1	9.0	1.6	84	[3]	E		1732-65

Measuring contacts



Ball Ø 0.6 mm

Ball Ø 1.0 mm

Ball Ø 1.0 mm

Measuring capacity

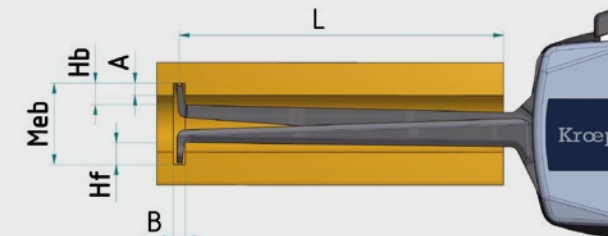

Meb Measuring range

A Groove depth

B Groove width

Hb Measuring contact movable

Hf Measuring contact fixed

L Measuring depth

Interfaces

Gauges CO / GO

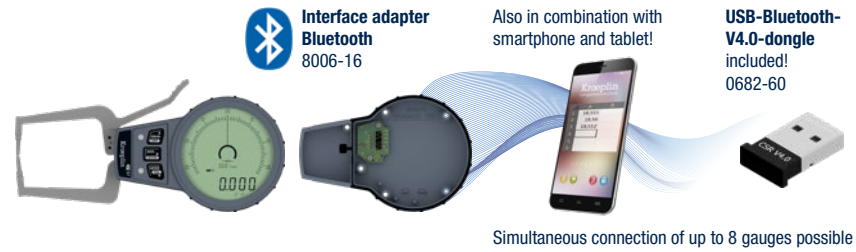
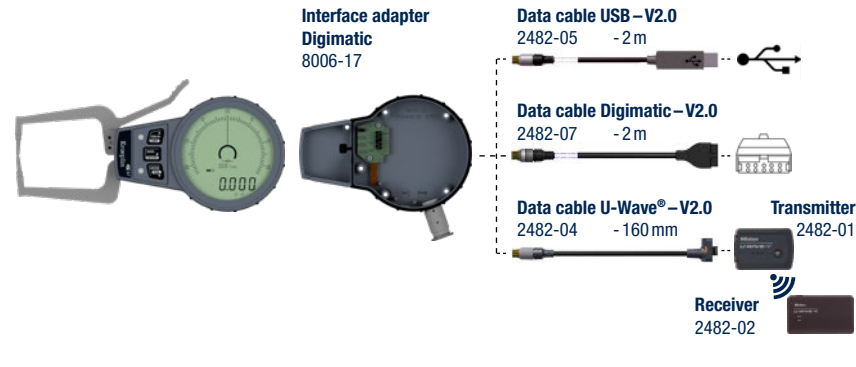

Gauges K / L

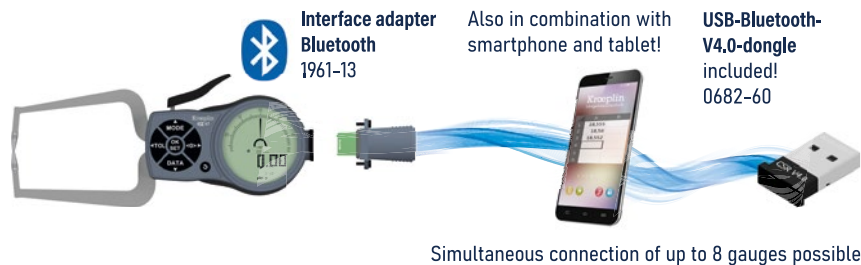
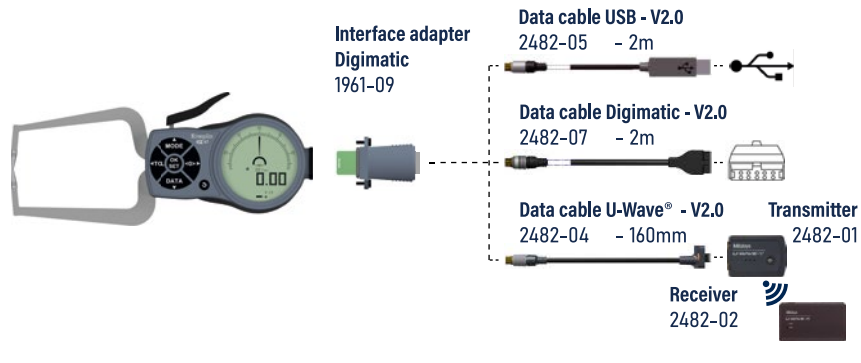

Accessories

- Wooden boxes for all series
- For order code please see technical details (HK = wooden box is included in delivery)



For measuring small parts the holding unit enables the gauge to be used with a measuring stand.

Gauge L102
(available on request)

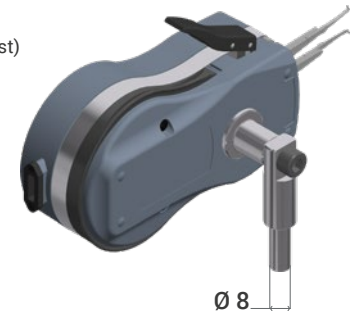

Holder CO / GO	order no.: 8004-58
Holder D1 / H1 / D2 / H2	order no.: 8004-50
Holder D4 / H4	order no.: 8004-55
Holder K / L	order no.: 8007-10

Special gauges

We are always searching for the best solution for your measuring problem, either mechanical or electronic.

In order to enable us to find the solution together and to design your special gauge, please kindly send us a drawing of the object to be measured and indicate tolerance and measuring force, and if possible, send us a sample of the part to be measured. Full information in your enquiry enables us to put forward the optimum design solution for your application.

The gauges shown are examples of special applications. For additional measuring applications we offer customised solutions.

► Measurements of undercuts with inclined measuring contacts.

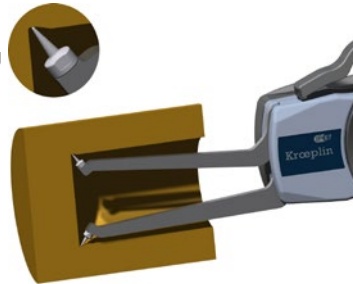

► Measurements of wall thicknesses in hard-to-access places.

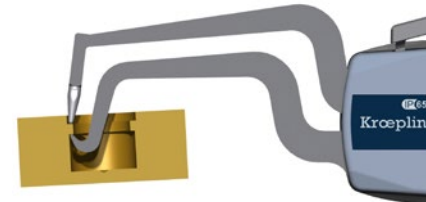

► Measurements in hard-to-access places with specially designed caliper arms.

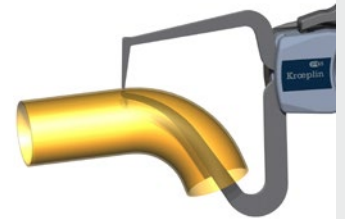

► Measurement of bottle diameters with depth measurement.

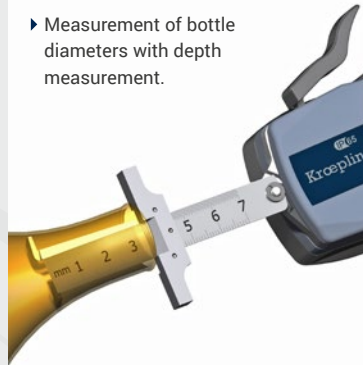

► Measurements of foamed materials with flat contacts and reduced measuring force.

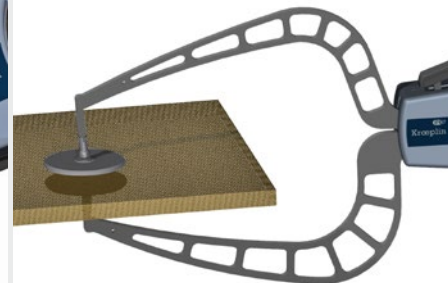

► Measurements of wall thicknesses at large undercuts with bayonet-type contacts (displacement in direction of the arrow before and after the measurement).

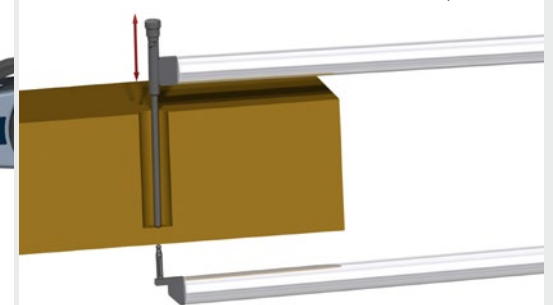

Detailed information and data sheets for all gauges are available on our webpage.

www.kroeplin.com

Foam inlays for storing measuring instruments

As an optional accessory we offer customised foam inlays for storing instruments e.g. in drawer cabinets.

Let us know the external dimensions as well as the number and type of Kroeplin gauges to be accommodated. If you would like to integrate different manufacturers' products or tools together with Kroeplin gauges in one inlay, we can implement this based on your 2D CAD data.

Based on your data we will send an appropriate offer. Please contact us.



Definitions

Diagram of deviation

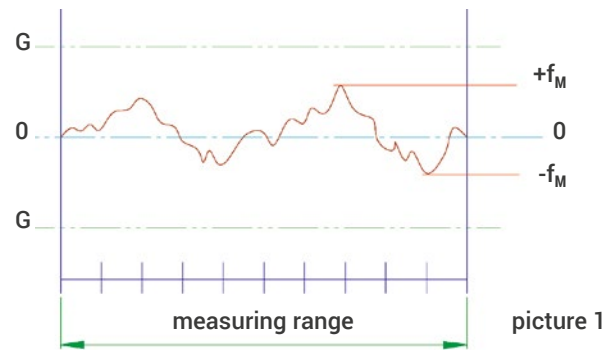

The individual diagram of deviation you can see in the certificate of quality which will be sent with every gauge.

Definitions

Terms of length test techniques see DIN 2257 part 1 and part 2 and International Vocabulary of Basic and General Terms in Metrology.

Foundations

This instruction follows approximately the checking instructions of the German standard DIN 878 for dial gauges and the checking instructions for caliper gauges according to VDI/VDE/DGQ 2618, page 13. The gauges are referred to as gauges with absolute measurement and adjustable zero point.

Measuring span Mes

The measuring span is the difference between starting value and final value of the measuring range.

Measuring range Meb

The measuring range of a gauge represents the range of measuring values in which given error limits must not be exceeded.

Range of indication Azb

The range of indication is the range between the highest and the lowest indication.

Numerical interval Zw

The numerical interval is the difference between two consecutive numbers of the last digit shown in the display. The numerical interval of a numerical scale is the modification of the value of a measured variable that causes the modification of the indication by one interval. The numerical interval corresponds to the scale interval of a line scale and is indicated in the unity of the measured variable.

Scale interval Skw

The scale interval is the modification of the value of a measured variable that causes the modification of the indication by one interval. The scale interval is indicated in the unity of the measured variable.

Deviation in the measuring range f_M

The deviation in the measuring range f_M represents the distance of ordinates between the highest and the lowest position in the deviation diagram, when the movable caliper arm closes. The **tolerance field G** for f_M is symmetrically positioned to the zero line.

Repeat precision f_w

The repeat precision f_w is a characteristic value for deviations of the measured quantity within the measuring range when the movable caliper arm closes (usually $n=5$). This margin of error is designated as **repeat limit r**.

Measuring force F_min, F_max

When the caliper arm closes, the measuring force F_{min} or F_{max} is determined at the top of the movable caliper arm. The gauge must be held in vertical position ≥ 200 mm.



Application area

- Mechanical engineering
- Automobile industry
- Aerospace industry
- Wire manufacturers
- Glass industry
- Dental laboratories
- Aerosol and packaging industry
- Foundries
- Foamed material industry
- Tube manufacturers
- Ceramic industry
- Medical institutes
- Special designs

Kroeplin GmbH
Gartenstraße 50 | 36381 Schluechtern | Germany

Phone: +49 6661 86-0
Fax: +49 6661 86-39

e-mail: sales@kroeplin.com
www.kroeplin.com

In the centre
of Europe.



The measure of all things.

Kroeplin Längenmesstechnik: Innovative and precise measuring instruments for exact measurement of lengths, diameters and thicknesses.

The measure of all things worldwide.

Subject to technical alterations. | Status: 10/2021